

\* 1-4 (Strang / Colonne montante / Montante)

Info: Verdrillte kabel verwenden / Utiliser des câbles torsadés  
 Utilizzare cavi twistati Art.336904 - Eldas 101 282 009

22 INT 1.2/00

\*1

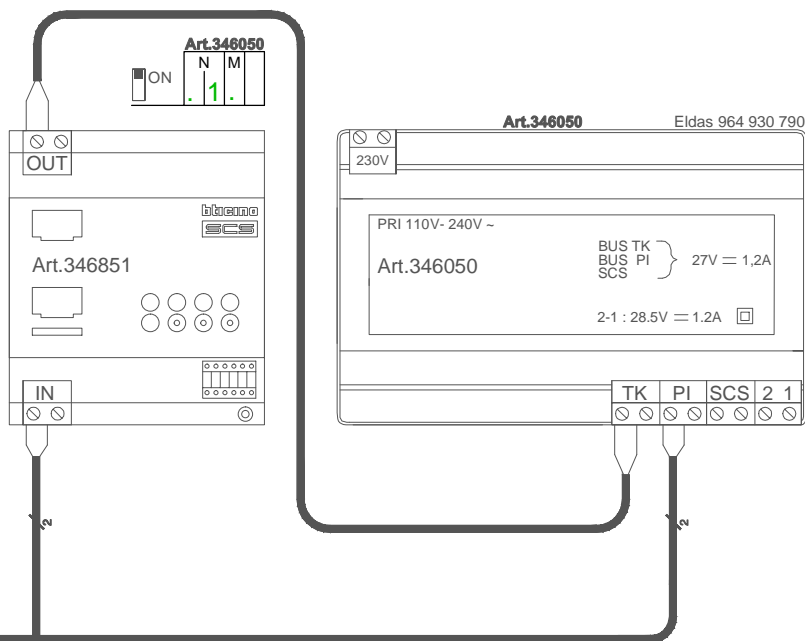

21 TAB 1.1/00

\* 1-4 (Strang / Colonne montante / Montante)

Info: Verdrillte kabel verwenden / Utiliser des câbles torsadés  
 Utilizzare cavi twistati Art.336904 - Eldas 101 282 009

22 INT 1.3/00

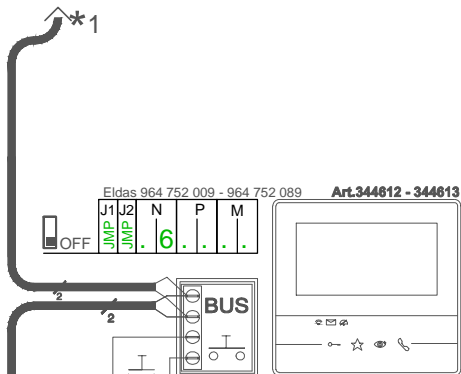

Eldas 964 752 009 - 964 752 089 **Art.344612 - 344613**

J1 J2 N P M  
 JMP JMP 6 . . . .

Etagen-Taster  
**Poussoir d'étage**  
 Chiamata al piano

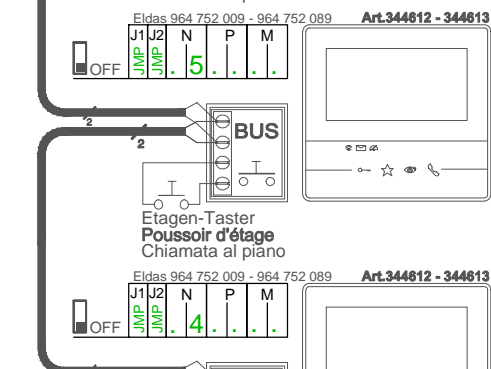

Eldas 964 752 009 - 964 752 089 **Art.344612 - 344613**

J1 J2 N P M  
 JMP JMP 5 . . . .

Etagen-Taster  
**Poussoir d'étage**  
 Chiamata al piano

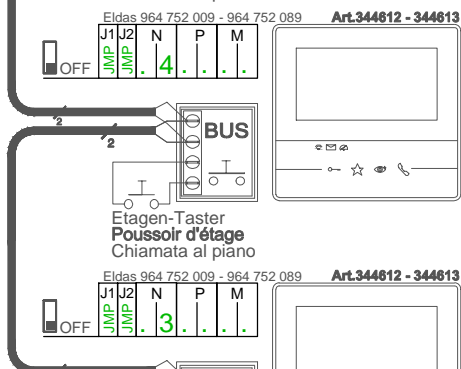

Eldas 964 752 009 - 964 752 089 **Art.344612 - 344613**

J1 J2 N P M  
 JMP JMP 4 . . . .

Etagen-Taster  
**Poussoir d'étage**  
 Chiamata al piano

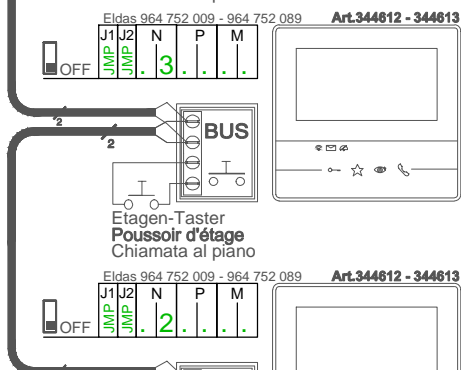

Eldas 964 752 009 - 964 752 089 **Art.344612 - 344613**

J1 J2 N P M  
 JMP JMP 3 . . . .

Etagen-Taster  
**Poussoir d'étage**  
 Chiamata al piano

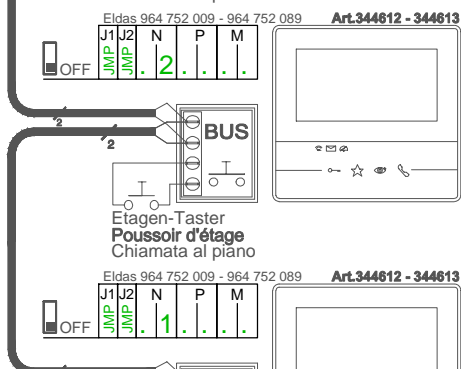

Eldas 964 752 009 - 964 752 089 **Art.344612 - 344613**

J1 J2 N P M  
 JMP JMP 2 . . . .

Etagen-Taster  
**Poussoir d'étage**  
 Chiamata al piano

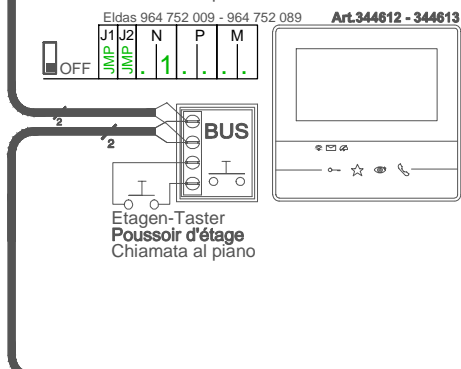

Eldas 964 752 009 - 964 752 089 **Art.344612 - 344613**

J1 J2 N P M  
 JMP JMP 1 . . . .

Etagen-Taster  
**Poussoir d'étage**  
 Chiamata al piano

22 INT 1.1/00

\* 1-4 (Strang / Colonne montante / Montante)

Info: Verdrillte kabel verwenden / Utiliser des câbles torsadés  
 Utilizzare cavi twistati Art.336904 - Eldas 101 282 009

22 INT 1.4/00

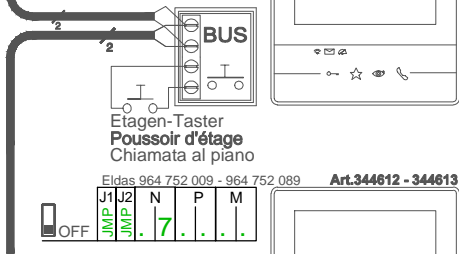
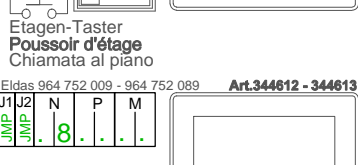
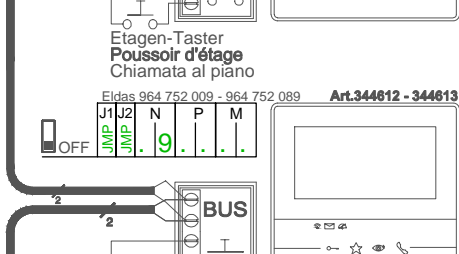
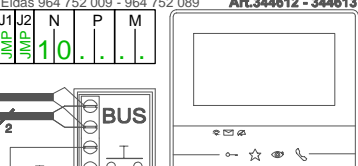
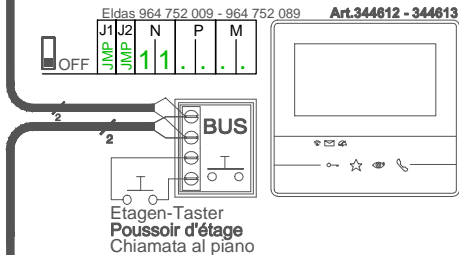
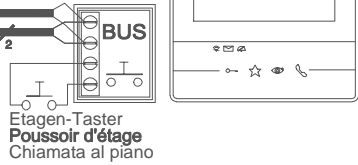
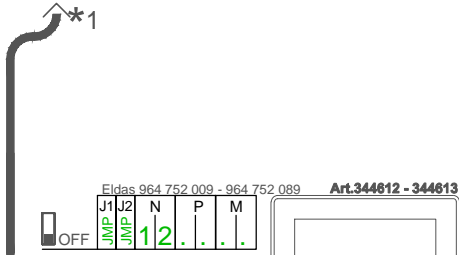

22 INT 1.2/00

\* 1-4 (Strang / Colonne montante / Montante)

Info: Verdrillte kabel verwenden / Utiliser des câbles torsadés  
 Utilizzare cavi twistati Art.336904 - Eldas 101 282 009

22 INT 1.5/00

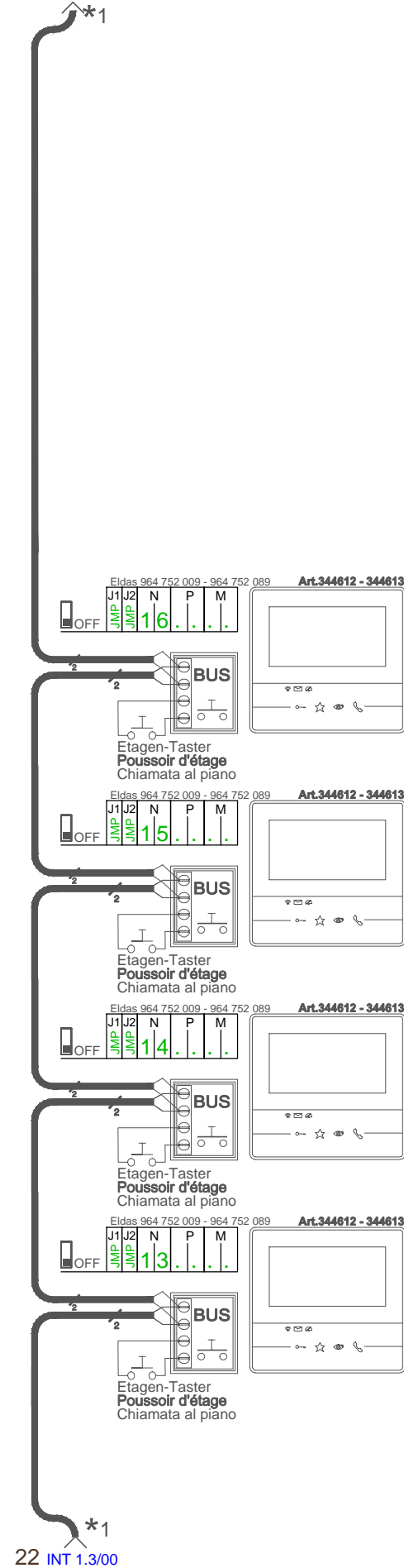

\* 1-4 (Strang / Colonne montante / Montante)

Info: **Verdrillte kabel verwenden / Utiliser des câbles torsadés**  
 Utilizzare cavi twistati Art.336904 - Eldas 101 282 009

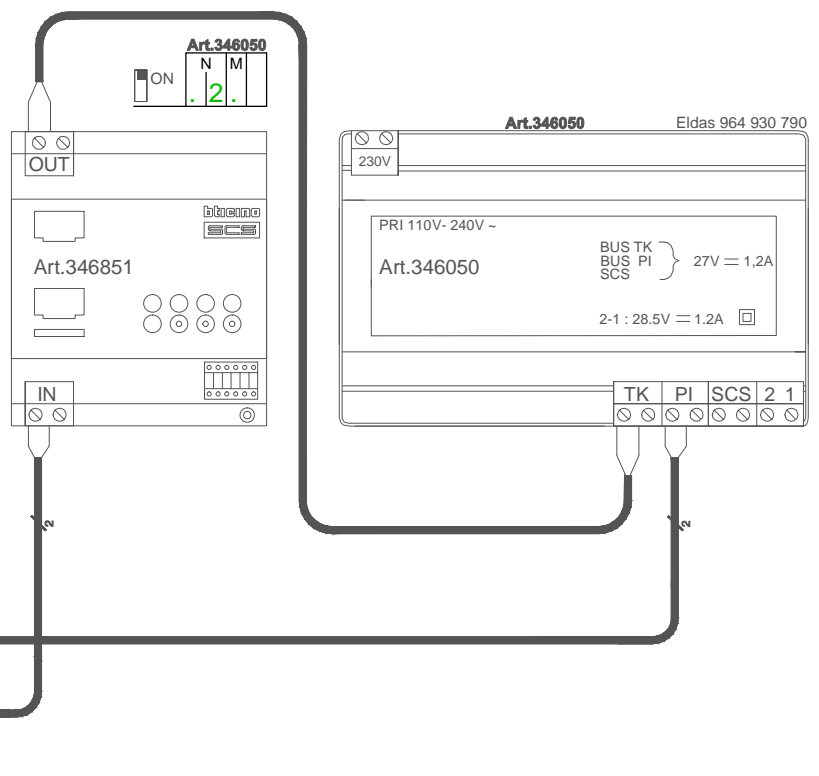
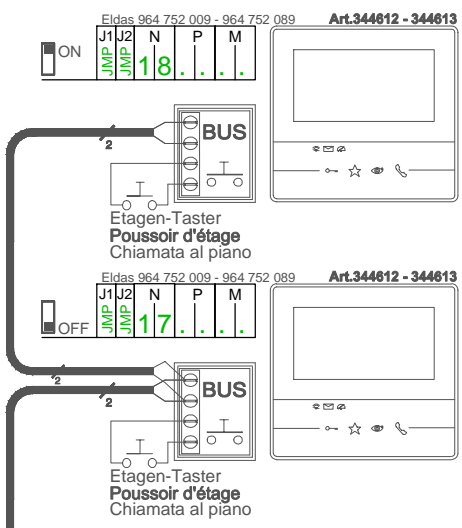

\*1  
 22 INT 1.4/00