

* 1-4 (Strang / Colonne montante / Montante)

X (Entfernen Sie J1 / Retirez le J1 / Rimuovi J1)

Info: X^i|a|q|c^A^a^|c^i, ^} a^} A^M^a^|c^A^A^e^a^|c^i^c^a^..

Utilizzare cavi twistati Art.336904 - Eldas 101 282 009

21 INT 1.4/00

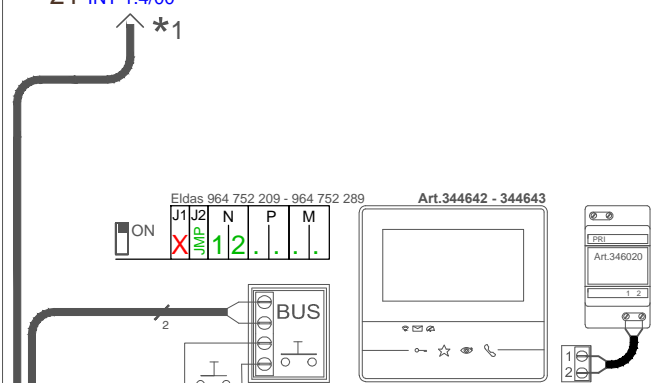

Eldas 964 752 209 - 964 752 289

Art.344642 - 344643

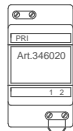

Etagen-Taster
 U|••|A^C^e^A^
 Chiamata al piano

**Entfernen Sie J1
 Retirez le J1
 Rimuovi J1**

Art.346020
 Eldas 964 930 490

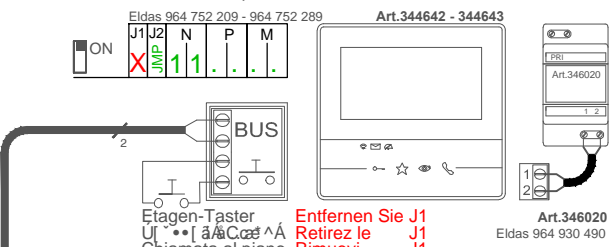

Eldas 964 752 209 - 964 752 289

Art.344642 - 344643

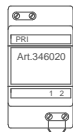

Etagen-Taster
 U|••|A^C^e^A^
 Chiamata al piano

**Entfernen Sie J1
 Retirez le J1
 Rimuovi J1**

Art.346020
 Eldas 964 930 490

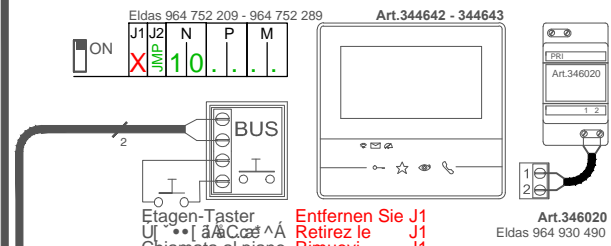

Eldas 964 752 209 - 964 752 289

Art.344642 - 344643



Etagen-Taster
 U|••|A^C^e^A^
 Chiamata al piano

**Entfernen Sie J1
 Retirez le J1
 Rimuovi J1**

Art.346020
 Eldas 964 930 490

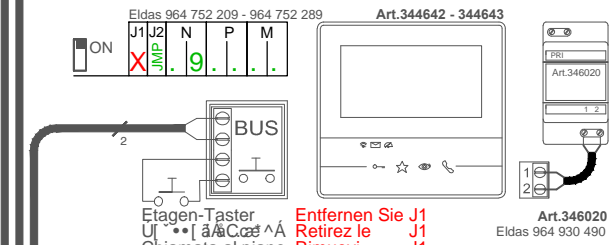

Eldas 964 752 209 - 964 752 289

Art.344642 - 344643

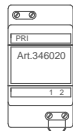

Etagen-Taster
 U|••|A^C^e^A^
 Chiamata al piano

**Entfernen Sie J1
 Retirez le J1
 Rimuovi J1**

Art.346020
 Eldas 964 930 490

Eldas 964 922 190

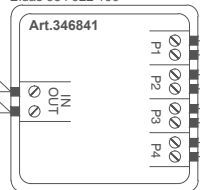

21 INT 1.2/00

* 1-4 (Strang / Colonne montante / Montante)

X (Entfernen Sie J1 / Retirez le J1 / Rimuovi J1)

Info: X^i:à|c^Áæ^|ç^i, ^} à} ÁWç^i/Á^Áè^Ái:æ...
 Utilizzare cavi twistati Art.336904 - Eldas 101 282 009

21 INT 1.6/00

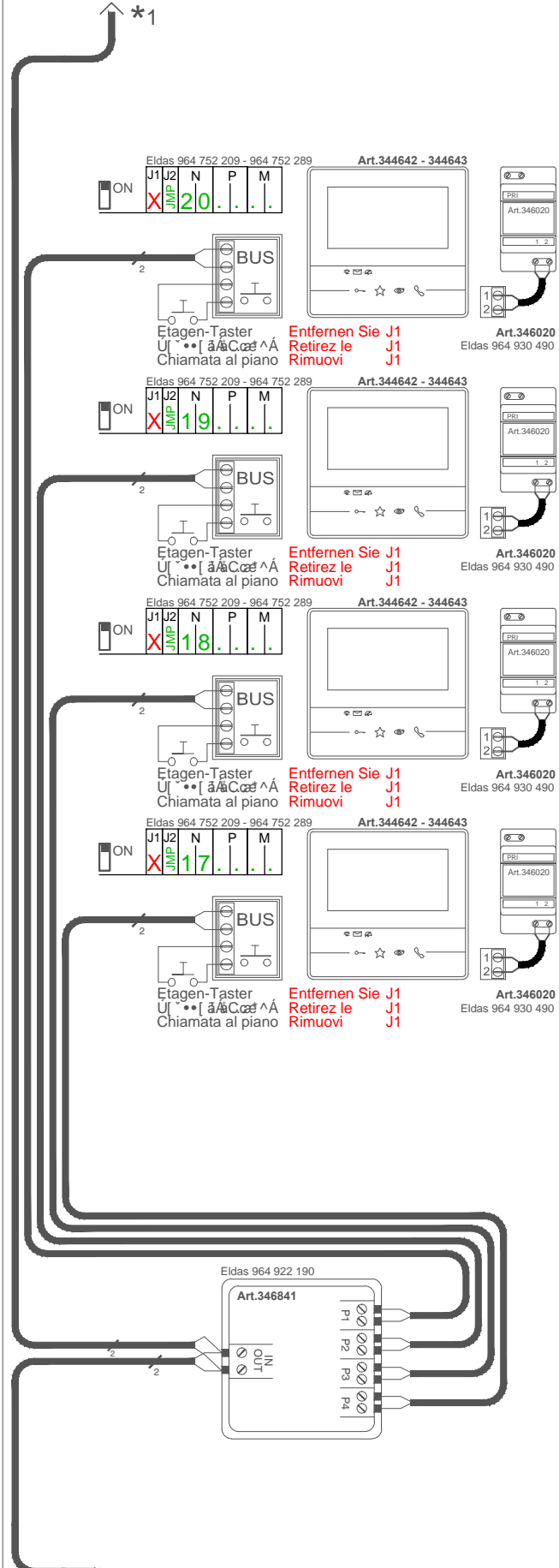

Eldas 964 752 209 - 964 752 289

Art.344642 - 344643

J1 J2 N P M
 X 2 0 . . .

Entfernen Sie J1
 Retirez le J1
 Rimuovi J1

Art.346020
 Eldas 964 930 490

Eldas 964 752 209 - 964 752 289

Art.344642 - 344643

J1 J2 N P M
 X 1 9 . . .

Entfernen Sie J1
 Retirez le J1
 Rimuovi J1

Art.346020
 Eldas 964 930 490

Eldas 964 752 209 - 964 752 289

Art.344642 - 344643

J1 J2 N P M
 X 1 8 . . .

Entfernen Sie J1
 Retirez le J1
 Rimuovi J1

Art.346020
 Eldas 964 930 490

Eldas 964 752 209 - 964 752 289

Art.344642 - 344643

J1 J2 N P M
 X 1 7 . . .

Entfernen Sie J1
 Retirez le J1
 Rimuovi J1

Art.346020
 Eldas 964 930 490

Eldas 964 922 190

Art.346841

P1
 P2
 P3
 P4

21 INT 1.4/00

* 1-4 (Strang / Colonne montante / Montante)

X (Entfernen Sie J1 / Retirez le J1 / Rimuovi J1)

Info: X'ia'ia'ic'Áaa'Á^, ^} à\} ÁWtã'Á^'Áèà'Á'Á' :aa'..

Utilizzare cavi twistati Art.336904 - Eldas 101 282 009

21 INT 1.7/00

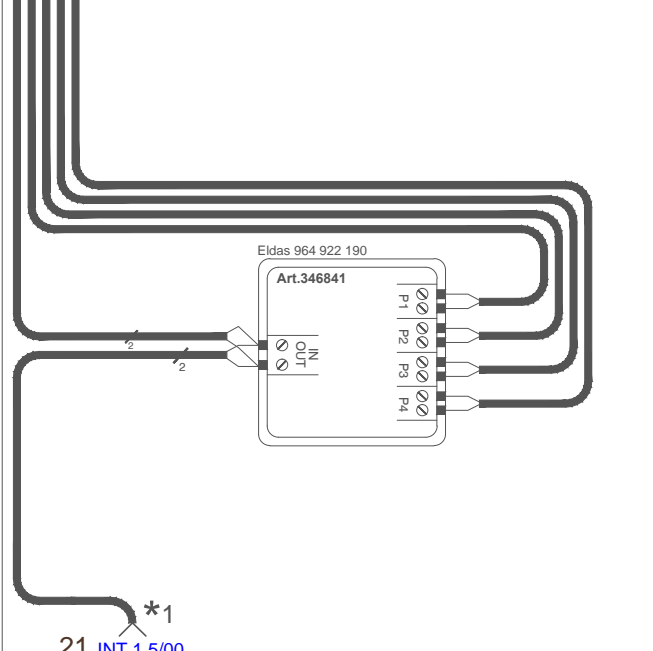
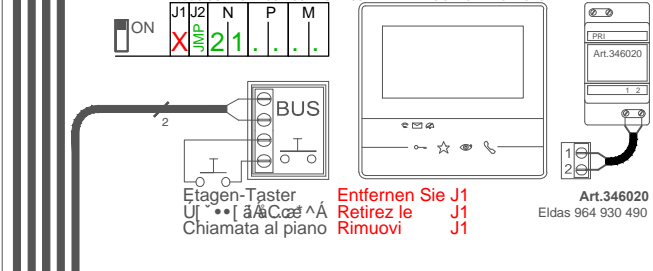
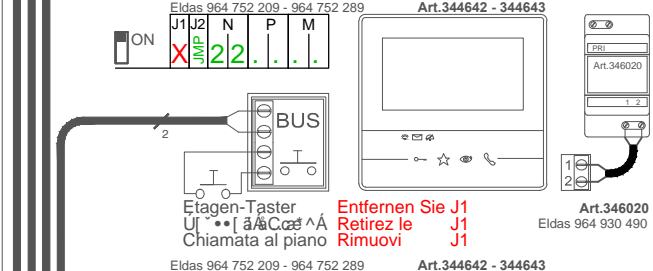
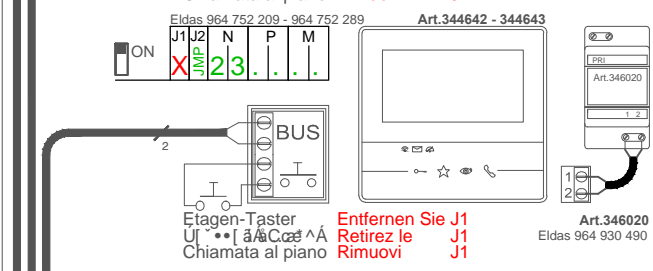
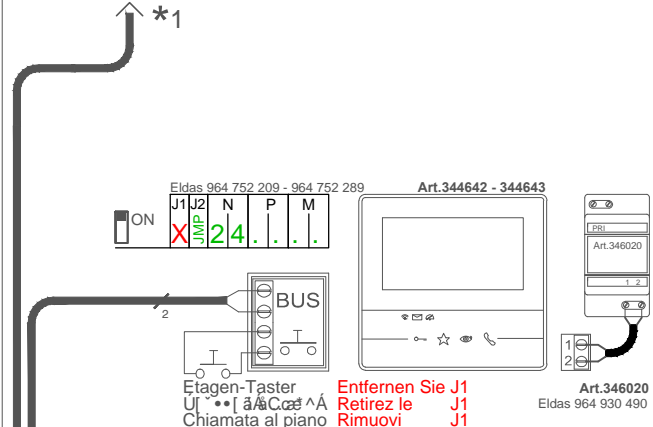

* 1-4 (Strang / Colonne montante / Montante)

X (Entfernen Sie J1 / Retirez le J1 / Rimuovi J1)

Info: X^i^à^i^c^À^æ^i^s^i^, ^) à^} Á^W^j^à^i^s^Á^B^è^i^Á^i^:^æ^..^:

Utilizzare cavi twistati Art.336904 - Eldas 101 282 009

