

* 1-4 (Strang / Colonne montante / Montante)
 X (Entfernen Sie J1 / Retirez le J1 / Rimuovi J1)

Info: X^i|á|q|c|Á|æ^|Á|, ^|á| }|Á|W|á^|Á^|Á|é|á^|Á|í|:|æ|..|.
 Utilizzare cavi twistati Art.336904 - Eldas 101 282 009

21 INT 1.2/00

41 INT 1.2/06

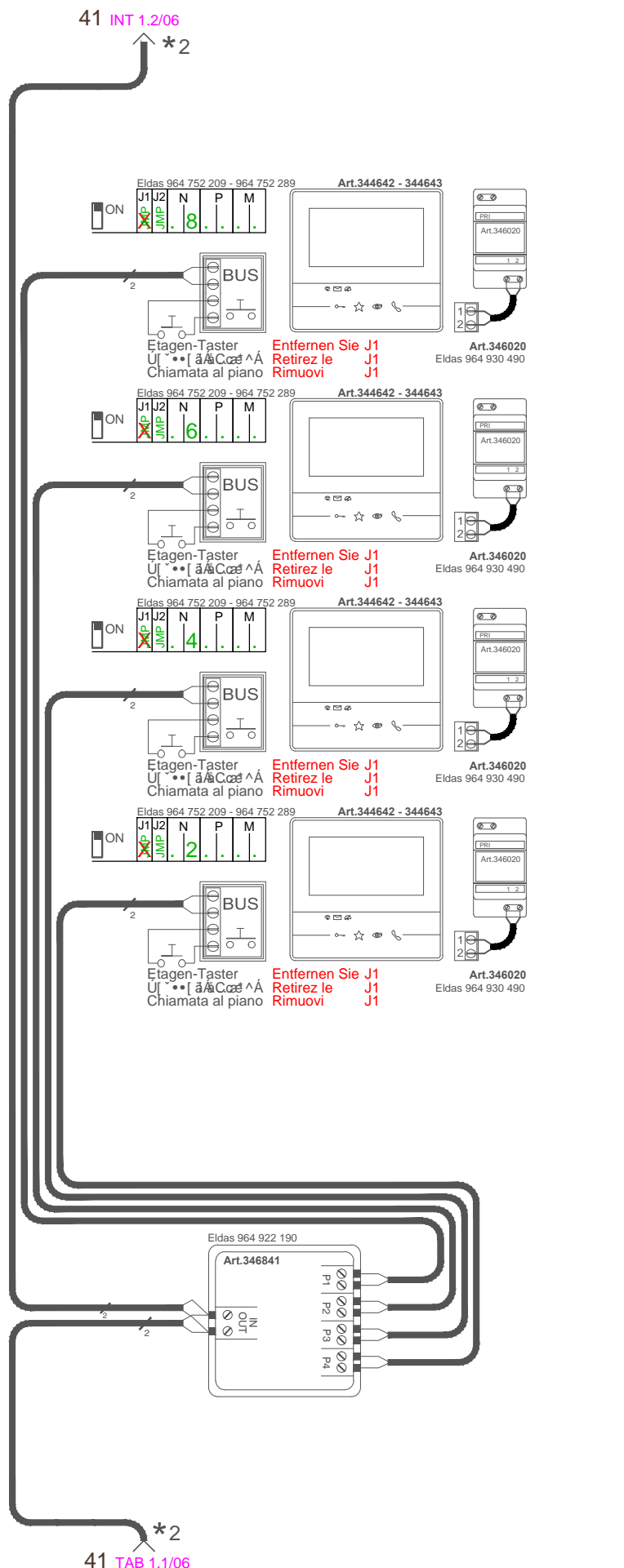
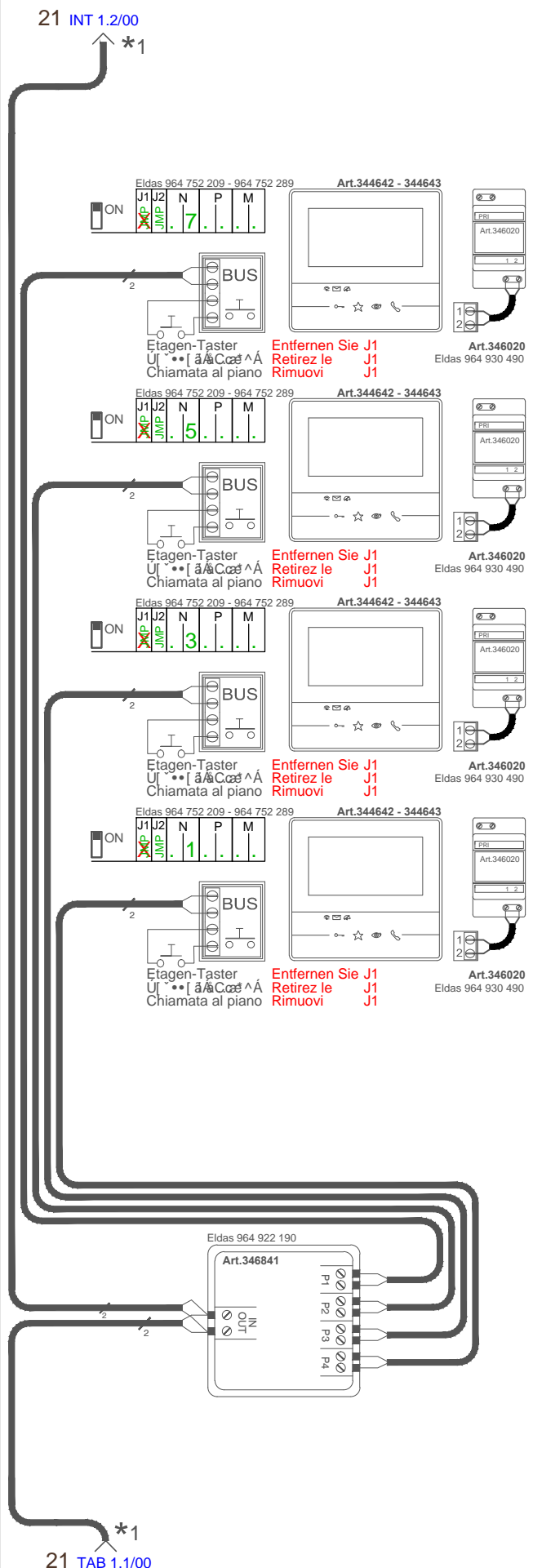

21 TAB 1.1/00

41 TAB 1.1/06

* 1-4 (Strang / Colonne montante / Montante)
X (Entfernen Sie J1 / Retirez le J1 / Rimuovi J1)

Info: X^i|a|q|c|A|a|A|s|^|^|a|^|A|W|a|^|^|A|e|a|^|^|A|^|a|..:
Utilizzare cavi twistati Art.336904 - Eldas 101 282 009

21 INT 1.3/00

41 INT 1.3/06

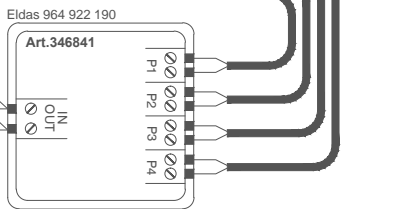
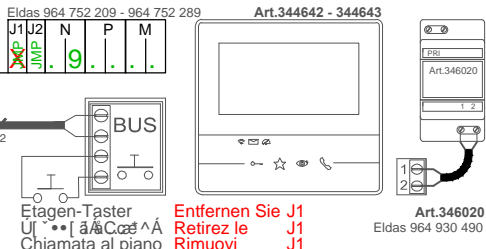
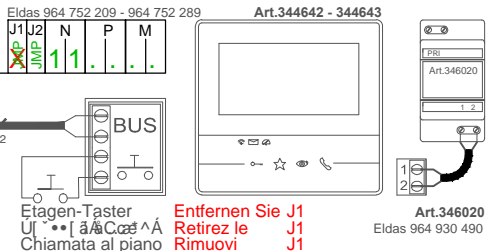
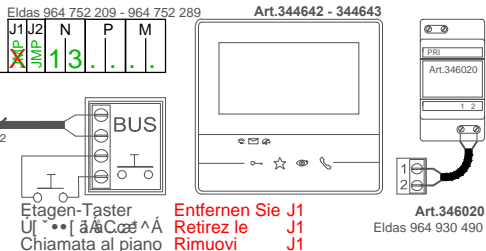
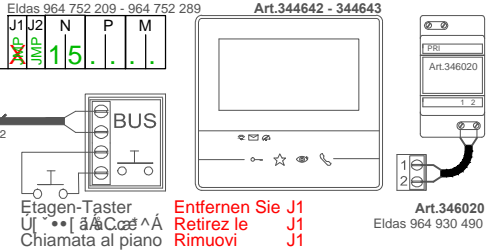

21 INT 1.1/00

41 INT 1.1/06

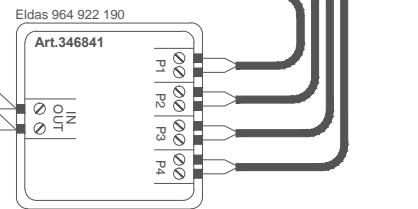
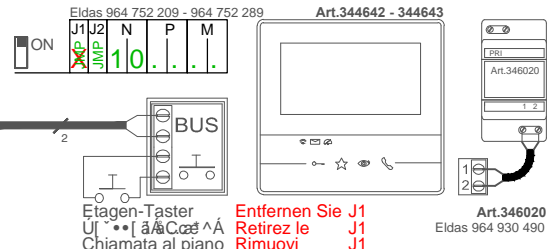
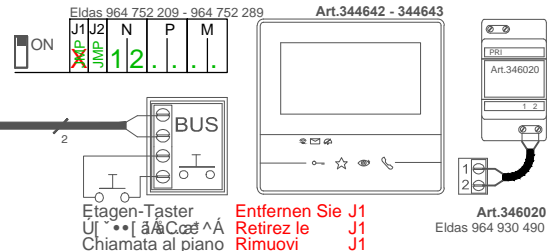
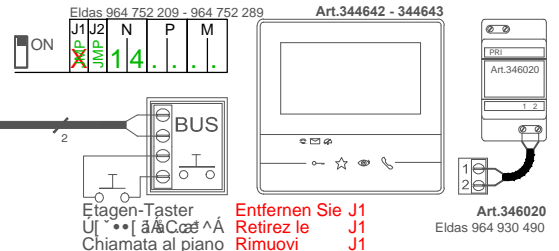
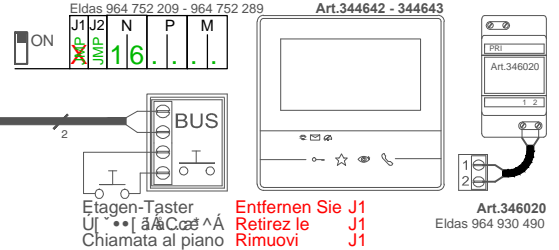

* 1-4 (Strang / Colonne montante / Montante)

X (Entfernen Sie J1 / Retirez le J1 / Rimuovi J1)

Info: X\i\à\i\c\À\æ\^{\i, \} \à\} \Ä\W\ä\^{\i\^ \&è\^{\i\ \æ\}\ \æ\}\

Utilizzare cavi twistati Art.336904 - Eldas 101 282 009

21 INT 1.4/00

*1

41 INT 1.4/06

*2

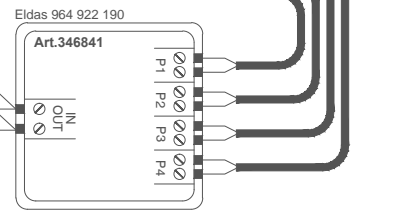
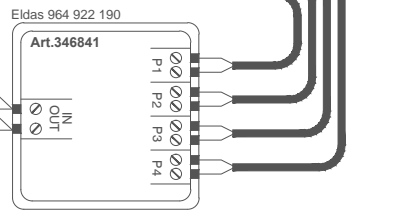
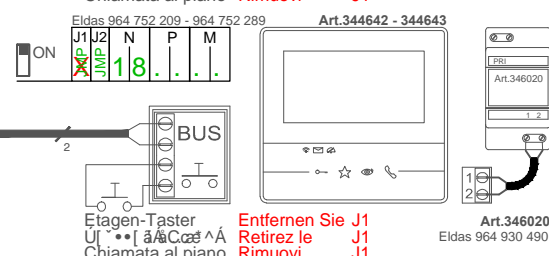
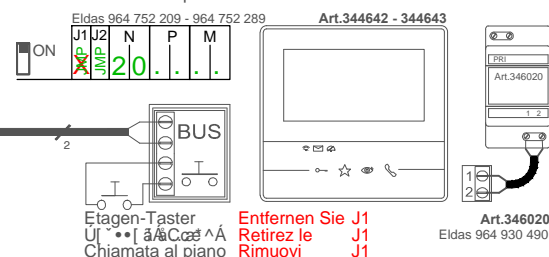
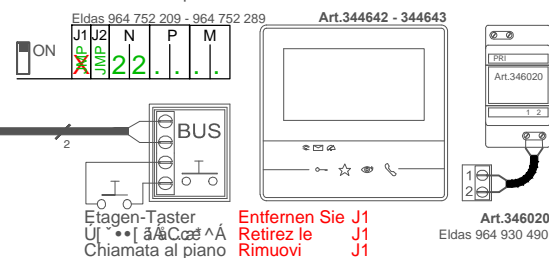
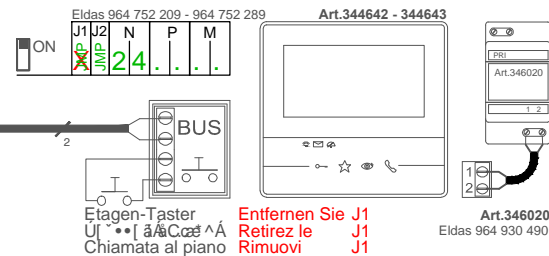
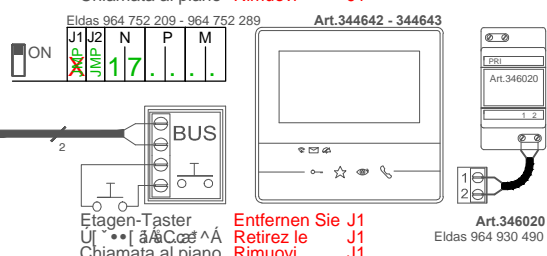
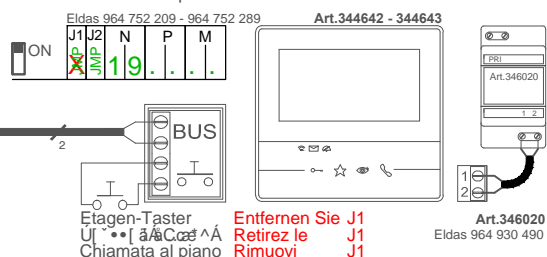
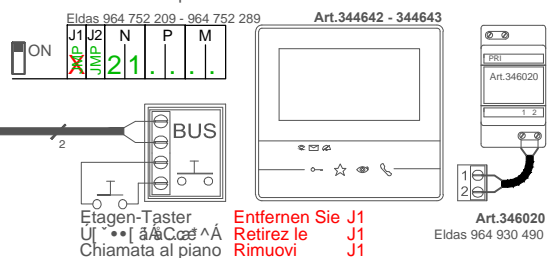
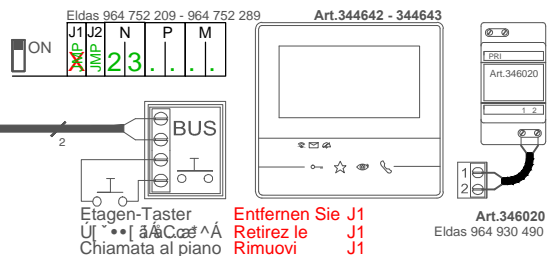

21 INT 1.2/00

*1

41 INT 1.2/06

*2

* 1-4 (Strang / Colonne montante / Montante)

X (Entfernen Sie J1 / Retirez le J1 / Rimuovi J1)

Info: X^1 à 1^4 (Strang / Colonne montante / Montante)

Utilizzare cavi twistati Art.336904 - Eldas 101 282 009

21 INT 1.5/00

*1

41 INT 1.5/06

*2

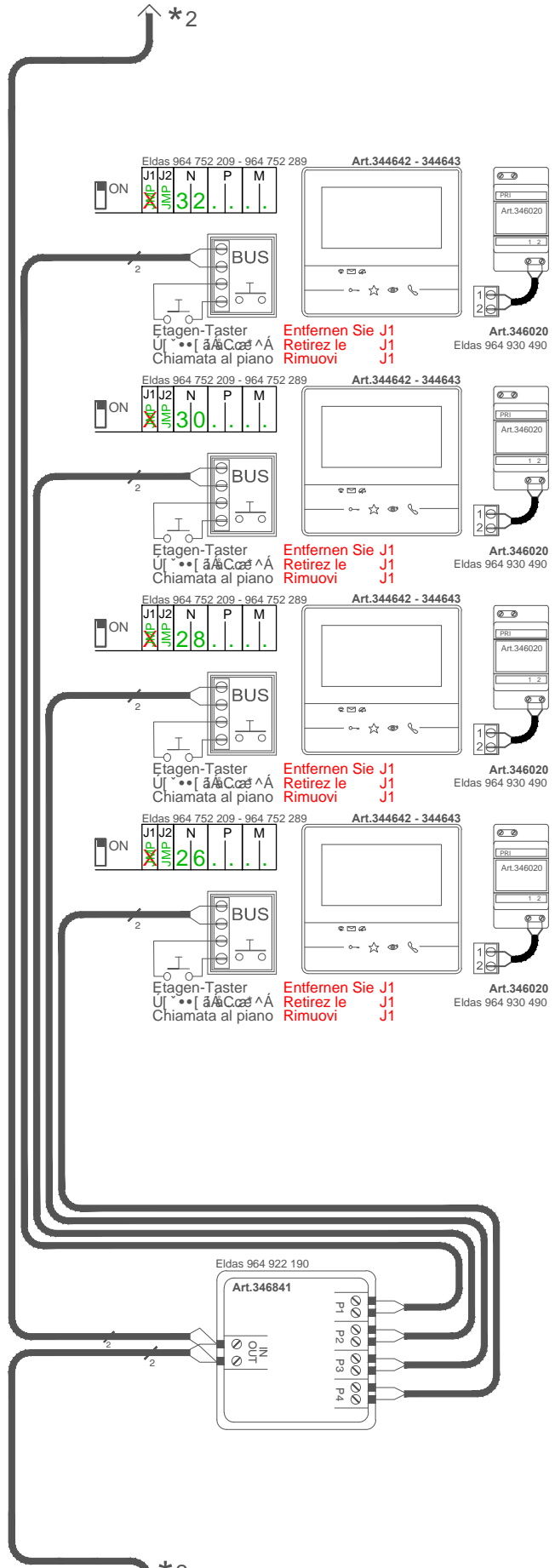
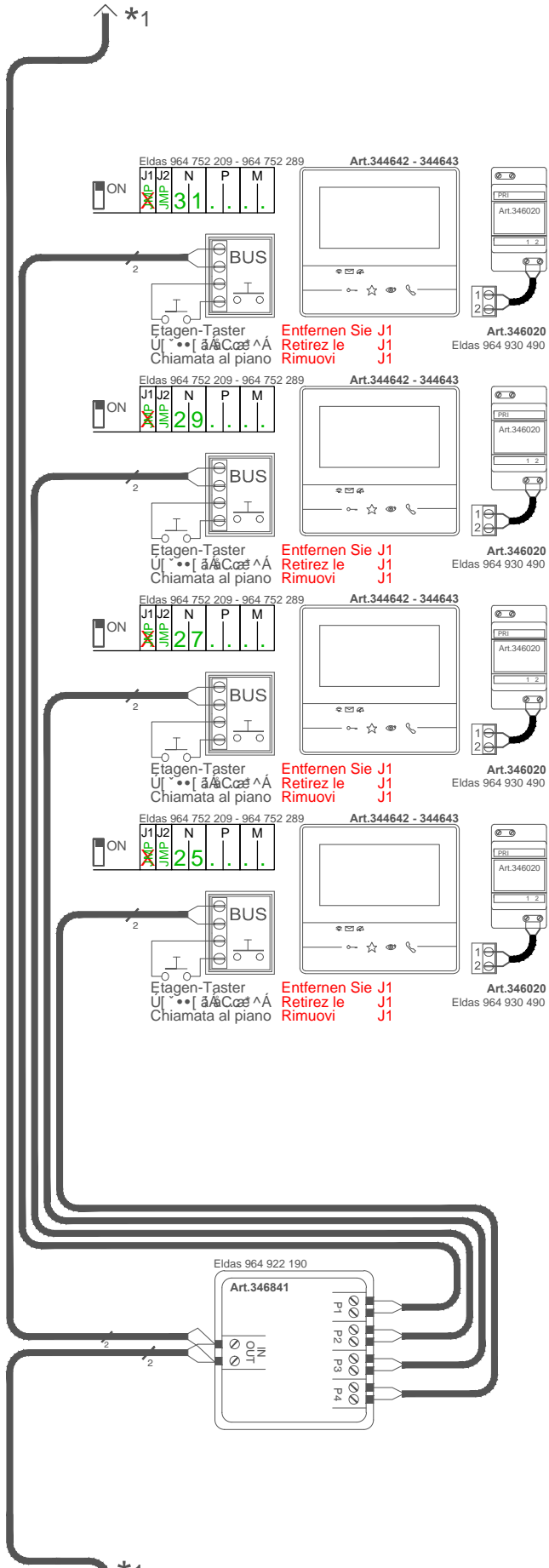

21 INT 1.3/00

41 INT 1.3/06

