

* 1-4 (Strang / Colonne montante / Montante)

X (Entfernen Sie J1 / Retirez le J1 / Rimuovi J1)

Info: Verdrillte kabel verwenden / Utiliser des câbles torsadés

Utilizzare cavi twistati Art.336904 - Eldas 101 282 009

21 INT 1.2/00

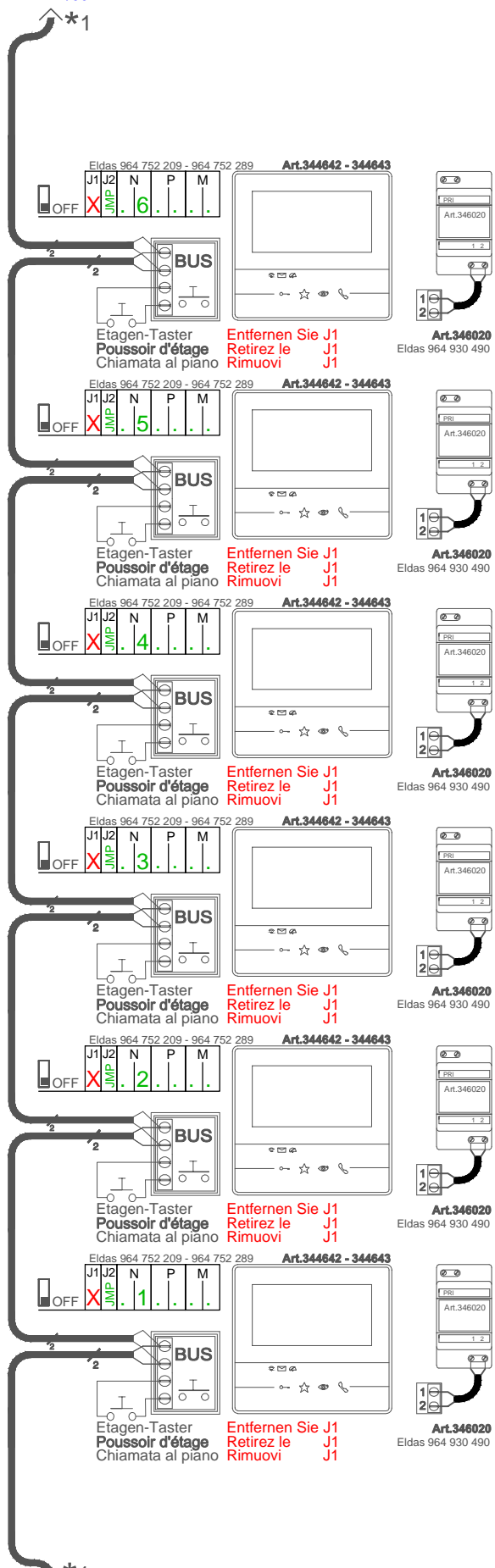

21 TAB 1.1/00

* 1-4 (Strang / Colonne montante / Montante)
 X (Entfernen Sie J1 / Retirez le J1 / Rimuovi J1)

Info: Verdrillte kabel verwenden / Utiliser des câbles torsadés
 Utilizzare cavi twistati Art.336904 - Eldas 101 282 009

21 INT 1.3/00

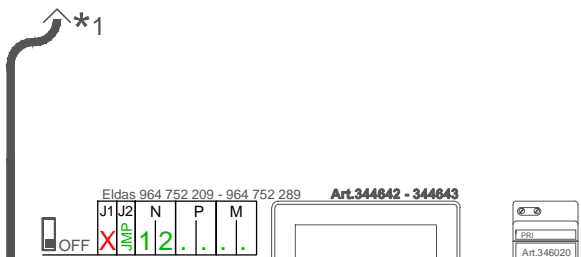

Eldas 964 752 209 - 964 752 289 **Art.344642 - 344643**

Entfernen Sie J1
 Retirez le J1
 Rimuovi J1

Art.346020
 Eldas 964 930 490

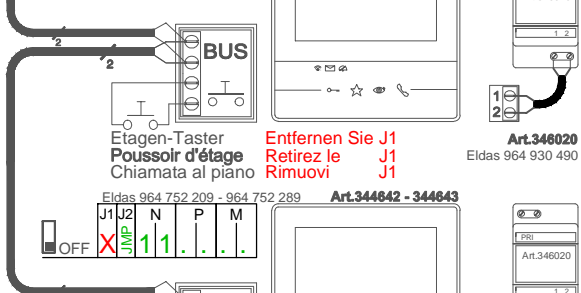

Eldas 964 752 209 - 964 752 289 **Art.344642 - 344643**

Entfernen Sie J1
 Retirez le J1
 Rimuovi J1

Art.346020
 Eldas 964 930 490

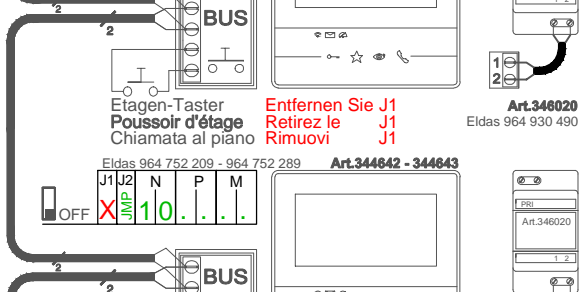

Eldas 964 752 209 - 964 752 289 **Art.344642 - 344643**

Entfernen Sie J1
 Retirez le J1
 Rimuovi J1

Art.346020
 Eldas 964 930 490

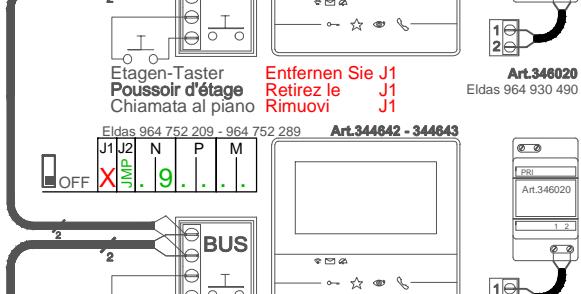

Eldas 964 752 209 - 964 752 289 **Art.344642 - 344643**

Entfernen Sie J1
 Retirez le J1
 Rimuovi J1

Art.346020
 Eldas 964 930 490

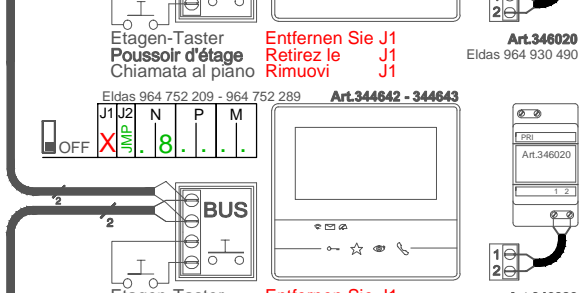

Eldas 964 752 209 - 964 752 289 **Art.344642 - 344643**

Entfernen Sie J1
 Retirez le J1
 Rimuovi J1

Art.346020
 Eldas 964 930 490

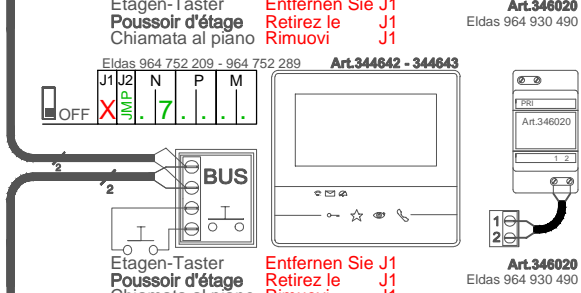

Eldas 964 752 209 - 964 752 289 **Art.344642 - 344643**

Entfernen Sie J1
 Retirez le J1
 Rimuovi J1

Art.346020
 Eldas 964 930 490

21 INT 1.1/00

*** 1-4 (Strang / Colonne montante / Montante)**
X (Entfernen Sie J1 / Retirez le J1 / Rimuovi J1)

Info: **Verdrillte kabel verwenden / Utiliser des câbles torsadés**
Utilizzare cavi twistati Art.336904 - Eldas 101 282 009

21 INT 1.4/00

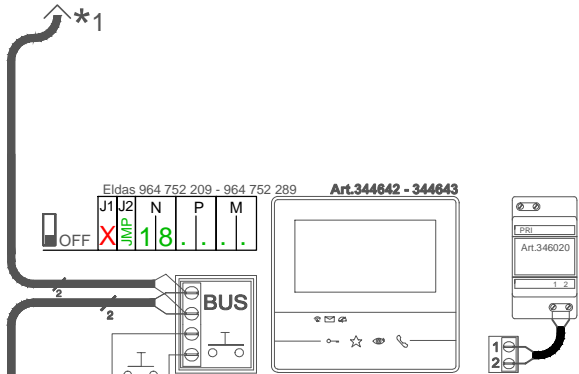

Eldas 964 752 209 - 964 752 289

Art.344642 - 344643

Etagen-Taster
Poussoir d'étage
 Chiamata al piano

Entfernen Sie J1
Retirez le J1
Rimuovi J1

Art.346020
 Eldas 964 930 490

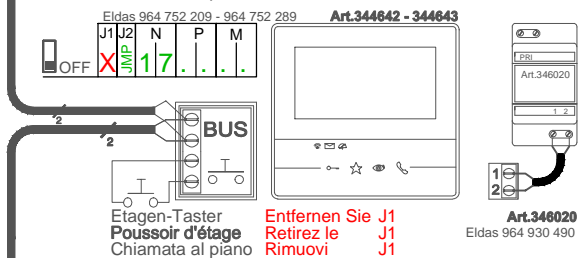

Eldas 964 752 209 - 964 752 289

Art.344642 - 344643

Etagen-Taster
Poussoir d'étage
 Chiamata al piano

Entfernen Sie J1
Retirez le J1
Rimuovi J1

Art.346020
 Eldas 964 930 490

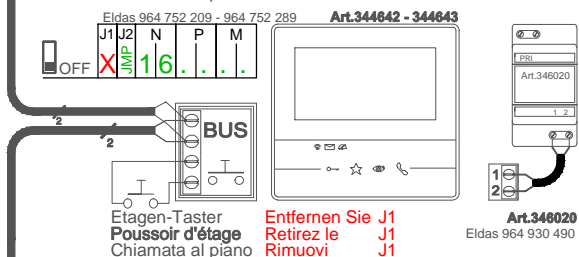

Eldas 964 752 209 - 964 752 289

Art.344642 - 344643

Etagen-Taster
Poussoir d'étage
 Chiamata al piano

Entfernen Sie J1
Retirez le J1
Rimuovi J1

Art.346020
 Eldas 964 930 490

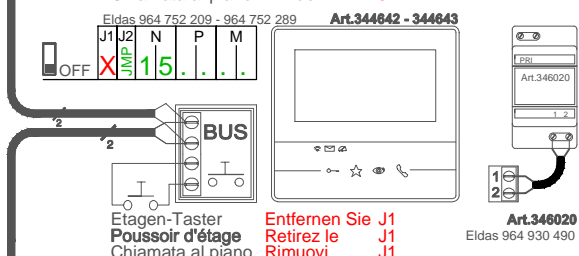

Eldas 964 752 209 - 964 752 289

Art.344642 - 344643

Etagen-Taster
Poussoir d'étage
 Chiamata al piano

Entfernen Sie J1
Retirez le J1
Rimuovi J1

Art.346020
 Eldas 964 930 490

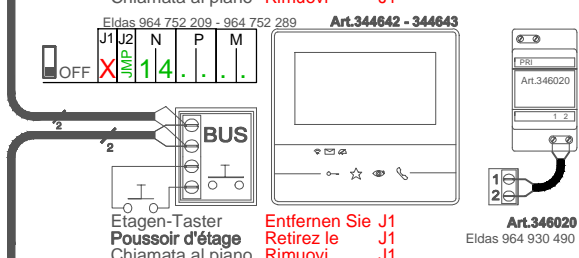

Eldas 964 752 209 - 964 752 289

Art.344642 - 344643

Etagen-Taster
Poussoir d'étage
 Chiamata al piano

Entfernen Sie J1
Retirez le J1
Rimuovi J1

Art.346020
 Eldas 964 930 490

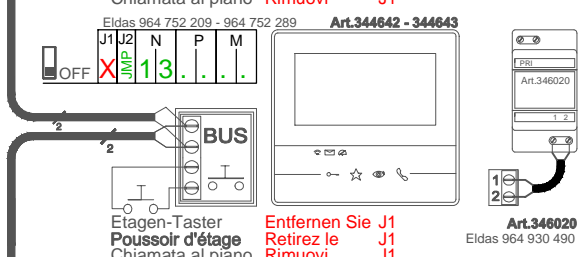

Eldas 964 752 209 - 964 752 289

Art.344642 - 344643

Etagen-Taster
Poussoir d'étage
 Chiamata al piano

Entfernen Sie J1
Retirez le J1
Rimuovi J1

Art.346020
 Eldas 964 930 490

21 INT 1.2/00

* 1-4 (Strang / Colonne montante / Montante)

X (Entfernen Sie J1 / Retirez le J1 / Rimuovi J1)

Info: Verdrillte kabel verwenden / Utiliser des câbles torsadés
Utilizzare cavi twistati Art.336904 - Eldas 101 282 009

21 INT 1.5/00

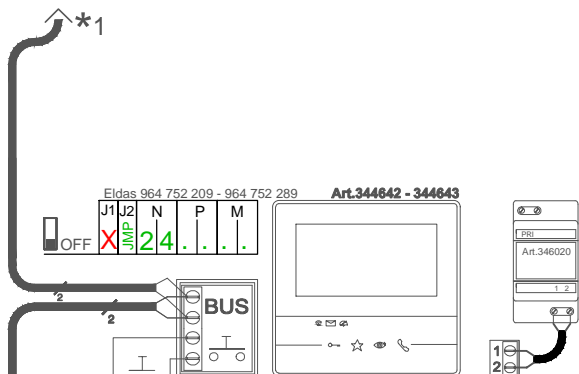

Eldas 964 752 209 - 964 752 289 **Art.344642 - 344643**

Entfernen Sie J1
Retirez le J1
Rimuovi J1

Art.346020
Eldas 964 930 490

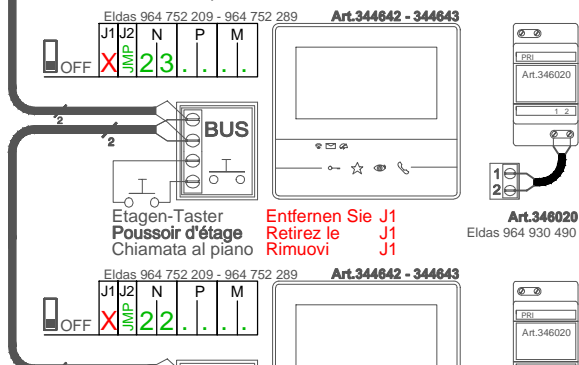

Eldas 964 752 209 - 964 752 289 **Art.344642 - 344643**

Entfernen Sie J1
Retirez le J1
Rimuovi J1

Art.346020
Eldas 964 930 490

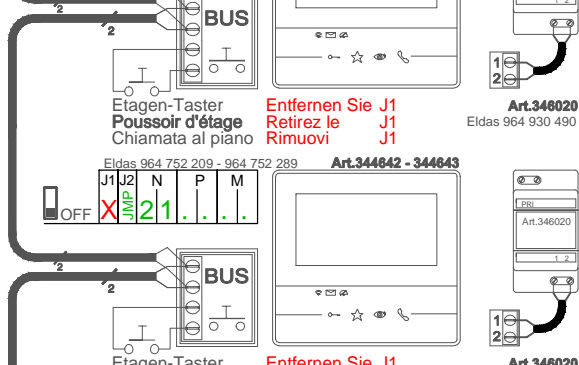

Eldas 964 752 209 - 964 752 289 **Art.344642 - 344643**

Entfernen Sie J1
Retirez le J1
Rimuovi J1

Art.346020
Eldas 964 930 490

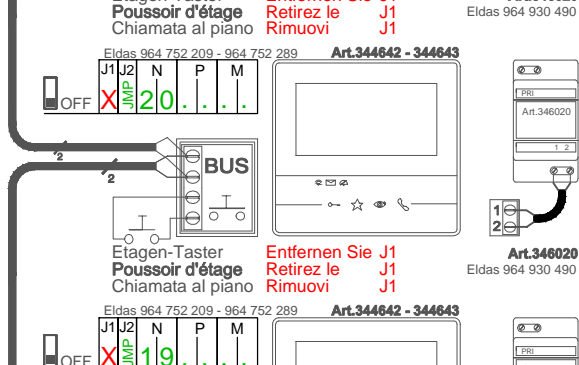

Eldas 964 752 209 - 964 752 289 **Art.344642 - 344643**

Entfernen Sie J1
Retirez le J1
Rimuovi J1

Art.346020
Eldas 964 930 490

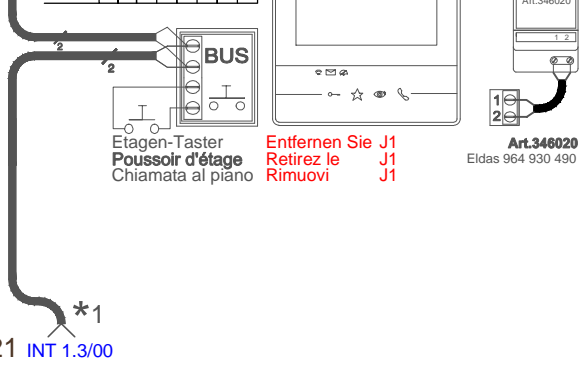

Eldas 964 752 209 - 964 752 289 **Art.344642 - 344643**

Entfernen Sie J1
Retirez le J1
Rimuovi J1

Art.346020
Eldas 964 930 490

21 INT 1.3/00

*** 1-4 (Strang / Colonne montante / Montante)**
X (Entfernen Sie J1 / Retirez le J1 / Rimuovi J1)

Info: Verdrillte kabel verwenden / Utiliser des câbles torsadés
 Utilizzare cavi twistati Art.336904 - Eldas 101 282 009

