

# PRINZIPSCHEMA - SCHÉMA DE PRINCIPE

## MEDIATOR, EFF-EFF, 4-BLOCK

### WICHTIG!

Bei Änderungen an der Konfiguration muss ein Reset der Anlage durchgeführt werden. Dies wird durch Unterbrechen der Spannungsversorgung für ca. 1 Minute erzielt.

### IMPORTANT!

En cas de modification de la configuration, il faut mettre le bloc d'alimentation hors tension pendant 1 minute environ!

RELAIS 342170

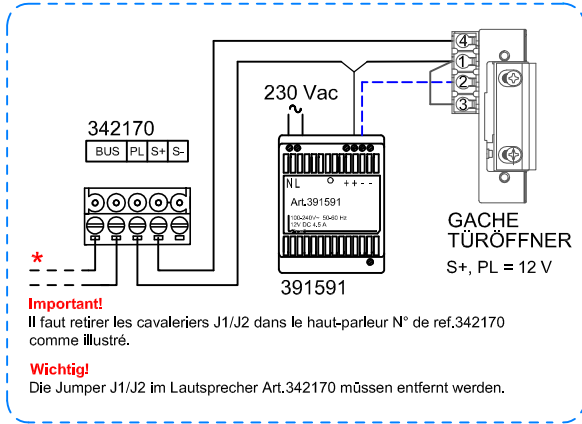

RELAIS 342170

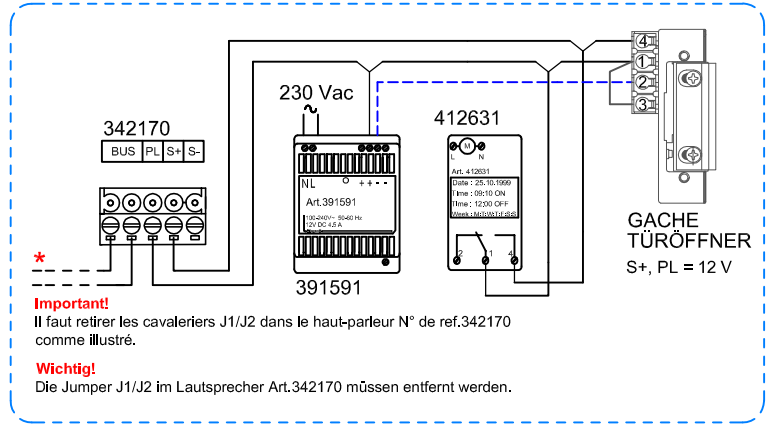

RELAIS 346250

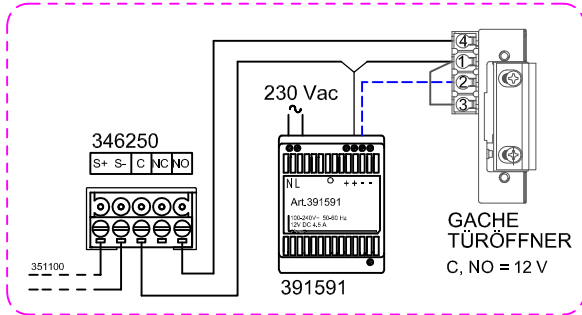

RELAIS 346250

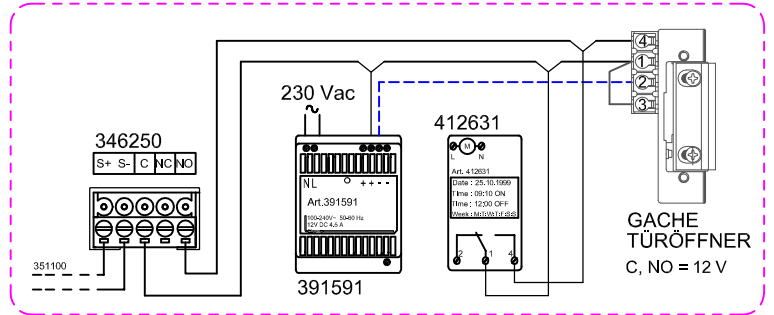

RELAIS 346230

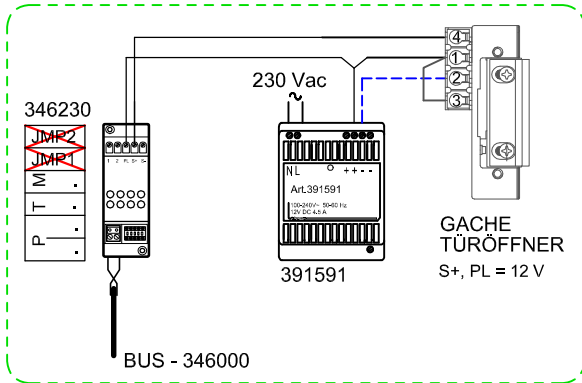

RELAIS 346230

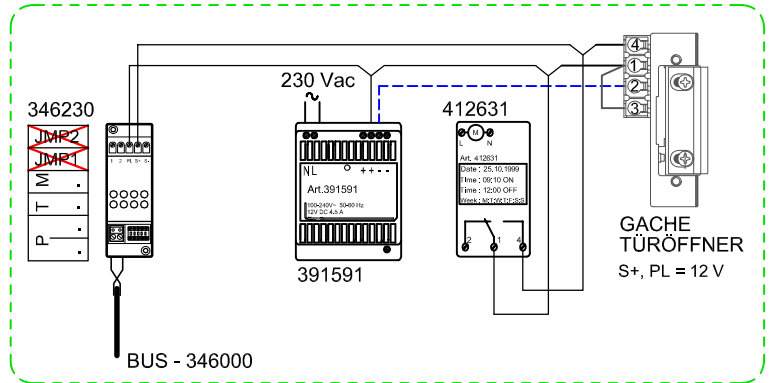

RELAIS 346210

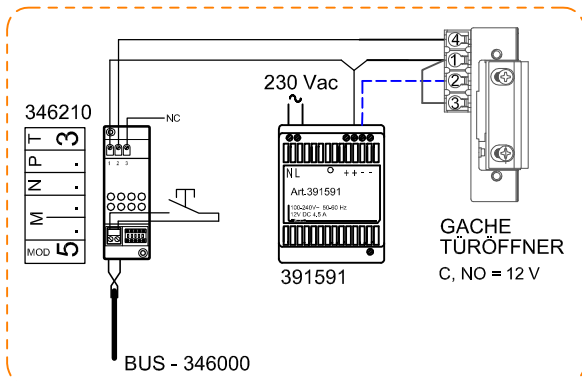

RELAIS 346210

